

Elvi

Installation manual

Elvi

Installation manual

Contents

Contents	4
Safety precautions	5
Components & features	6
1. Unpack Elvi	8
2. Install wall dock	10
3. Install charging cable	16
4. Activate Elvi	17
5. Install station	18
6. Install cable dock	19
7. Charge charging cable	21
8. Charge with Elvi	23
9. Troubleshooting	24
10. Warranty	26
11. Declaration of conformity	27

Safety precautions

 **Warning:** Risk of electric shock.

- Read the supplied documentation carefully to familiarize yourself with all safety instructions and regulations before using this product.
- This product is designed and tested in accordance with international standards.
- The use of this product is limited to those applications it is designed for.
- Installation, maintenance and repairs of this product are only to be performed by qualified personnel.
- Incorrect installation or repairs may cause hazardous situations for the user of this product.
- This product is used in combination with a power source.
- Always switch off power before any maintenance activity.
- This product contains no user-serviceable parts. Consult EVBox or your distributor for more information. Do not attempt to service or repair the charging station yourself!
- Make sure that the product is only used under the correct operating conditions.
- Make sure that the main power is disconnected before storing or transporting this product.
- Make sure that the power line to Elvi is installed on a dedicated circuit breaker (MCB) on your service panel. The installation must incorporate an adequate residual-current device (RCD). The MCB must be in line with the capacity of the charging cable (3.7, 7.4, 11, 22 kW). In case the amperage rating of the charging cable is different than the amperage rating of the (MCB), the installer/user must change the station settings in the mobile app and/or web platform for station management as provided by the operator or service provider for this product.

The installing party must always ensure that the charging station is installed according to the local regulations. The installation settings of the service panel must always be adjusted by a qualified electrician.

EVBox is not responsible for any damage that occurs if this product is transported in a different packaging than the packaging in which the product was originally supplied. Store this product in a dry environment; the storage temperature must be between -25 °C and +60 °C.

EVBox strives to manufacture products of the highest quality. EVBox products bear the CE certification and are compliant with the essential requirements of EMC Directive 2014/30/EU and Low Voltage Directive 2014/35/EU.

More details can be found at evbox.com or in this installation manual.

EVBox products are sold with a limited warranty described at evbox.com/general-terms-conditions.



Components & features

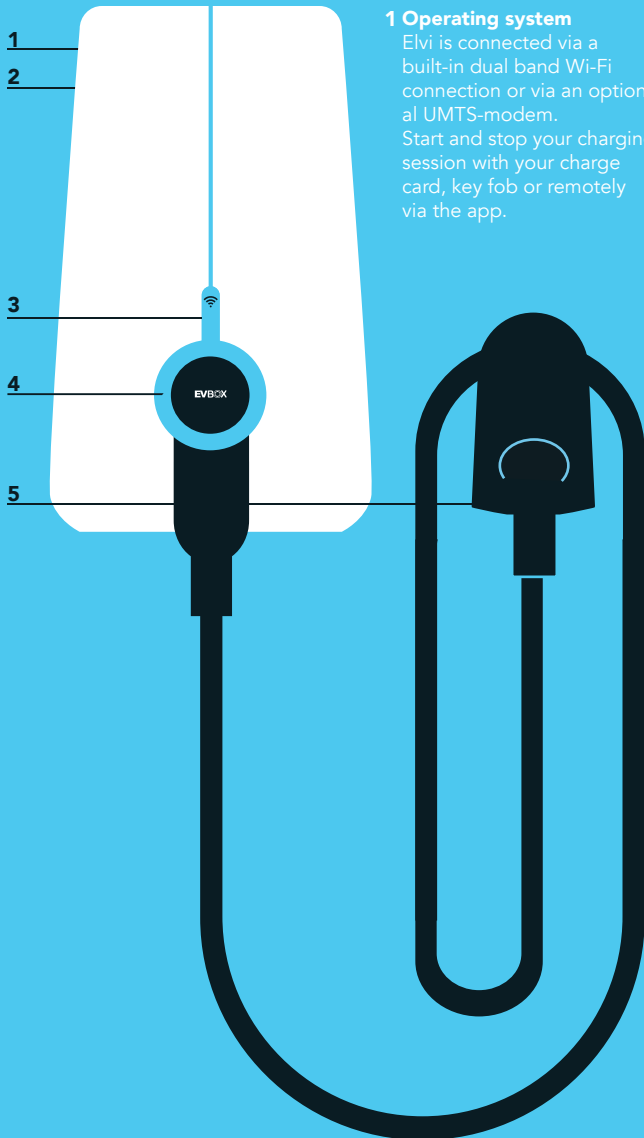

1 Operating system

Elvi is connected via a built-in dual band Wi-Fi connection or via an optional UMTS-modem. Start and stop your charging session with your charge card, key fob or remotely via the app.

2 Housing

Elvi consists of a wall dock, a charging station and a charging cable. Elvi is designed with rugged, high-impact strength plastics that make its housing durable, robust, weather-resistant and wear-resistant.

3 Card reader

This is the area where you scan your charge card or key fob. Elvi reads the data from your card to start or stop a charging session.

4 LED indicator

EVBox is the innovator behind the LED ring. This smart status indicator helps you understand what Elvi is doing at all times.

5 Charging cable & cable dock

The Elvi charging cable is compatible with all types of electric vehicles that can handle capacities from 3.7 kW up to 22 kW.

The cable dock (sold separately, part. No. 290135) secures the cable in its position when Elvi is not in use.

Note: Make sure to select a charging cable/plug that is compatible with your car.

Dimensions (in mm)

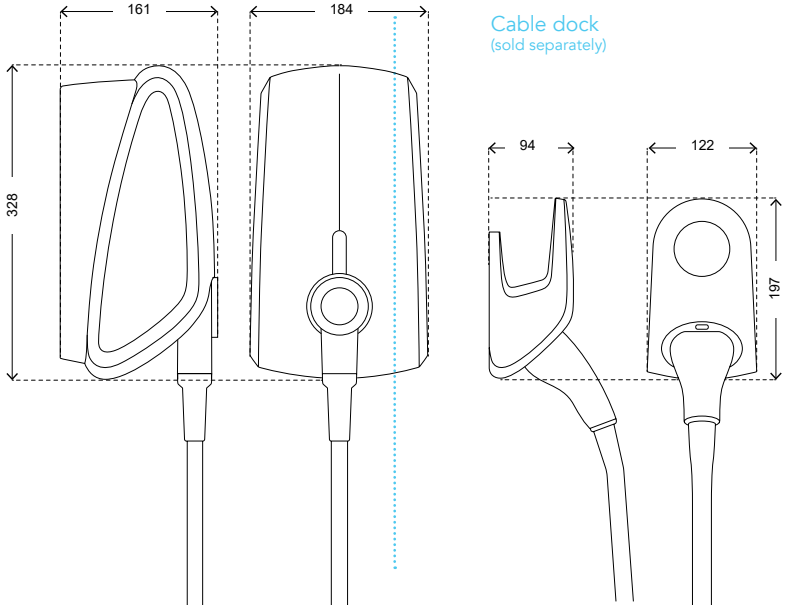

Components

Wall dock

Station

Cable dock
(sold separately)

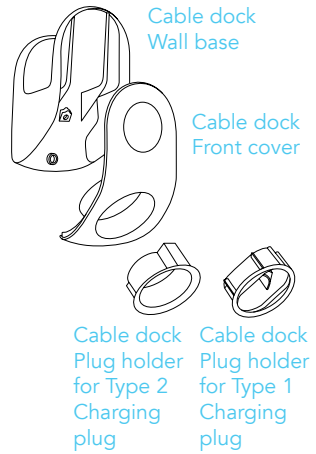
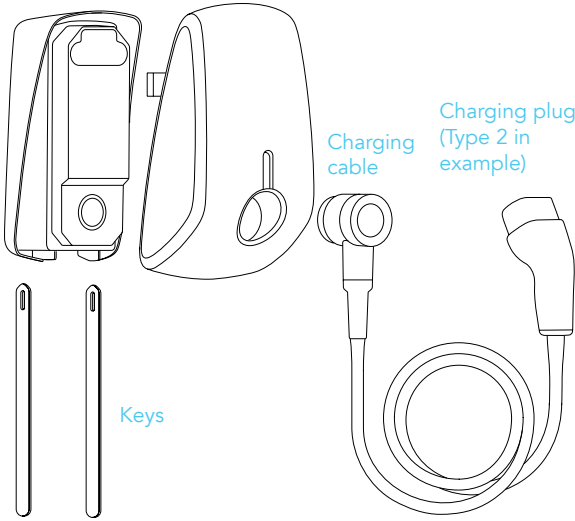

1. Unpack Elvi

1.1

Place Elvi package on a flat and stable surface.
Remove sleeve.

1.2

Set the boxes aside.

Box 1 contains the charging station.

Box 2 contains the charging cable.

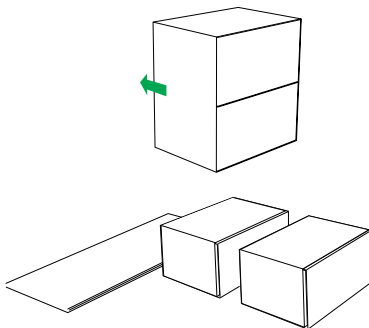

1.3

Open the charging station box.

Put the instructions folder (A) aside.

The keys (B) found in this folder are only needed for removing the charging station (C) from its wall dock (D) (in case of maintenance or to change the charging cable).

Note: After installation, hand over the folder to the user, as it also contains the charge card (E), the key fob (F) and station ID + security code (G).

1.4

Take out the charging station together with its cardboard buffer from its box.

1.5

Take out the wall dock from its box.

Skip this step if the wall dock is already installed.
(In this case, the wall dock is not included in the box.)

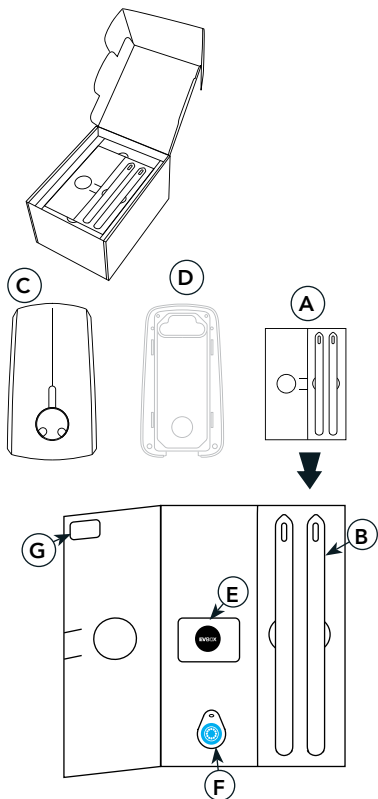

1. Unpack Elvi

Wall dock
already installed?

NO

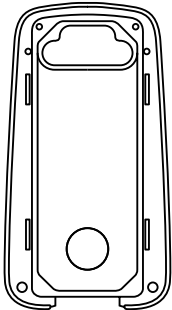

Go to next page

YES

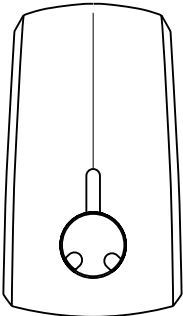

Go to page 13

2. Install wall dock

 **Warning:** Risk of electric shock.

Before installing the wall dock, make sure that the power line you're using is switched off on your service panel.

Make sure that the power line to Elvi is installed on a dedicated circuit breaker (MCB) on your service panel. The installation must incorporate an adequate residual-current device (RCD). The MCB must be in line with the capacity of the charging cable (3.7, 7.4, 11, 22 kW). In case the amperage rating of the charging cable is different than the amperage rating of the (MCB), the installer/user must change the station settings in the mobile app and/or web platform for station management as provided by the operator or service provider for this product.

Be aware that local regulations may be applicable and may vary depending on your region/country of residence. The installing party must always ensure that the station is installed according to the local regulations.

The installation settings of your service panel must always be adjusted by a qualified electrician.

Tools you need to install the wall dock

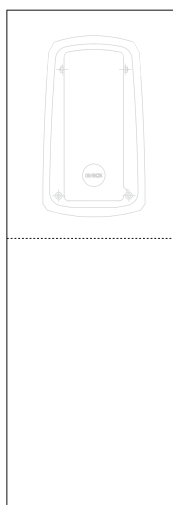

sleeve with
drilling template

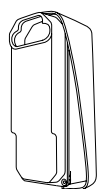

Included
in the box

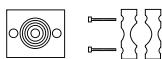

rubber seal strain relief



1x bit T20

1x bit T25

1x bit T30



4x screw
5 x 70 mm



4x plug
8 x 65 mm

Not included
in the box



flat-head
screwdriver



bit-holding
screwdriver



bubble
level

drill

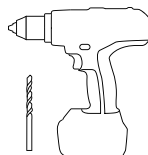

8 mm
drill bit



knife

2. Install wall dock

Installation advice

Ground connection advice	TN-system	PE-cable
	TT-system IT-system	Earth electrode installed separately (self-installed)
Input	1-phase	230 V ±10% 50/60 Hz
	3-phase	400 V ± 10% 50/60 Hz
MCB	C-characteristic (MCB must be selected to match the amperage settings of the charging station, considering MCB manufacturer specifications)	
RCD	40 A, 30 mA AC type A	

Note for the installer: In case of a TT or IT electric grid with 230 V from line to line, Elvi must be installed with 1-phase by connecting the clamps on L1 and N.

Service wiring

Option1: 400 V 3-phase with neutral

For 3-phase use of a Wye-connected secondary, all three phases (L1, L2 and L3) and neutral must be connected. Each phase voltage must measure 230 V to neutral.

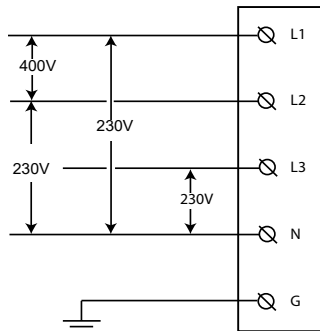

2. Install wall dock

Option 2: 230 V 1-phase with neutral

For 1-phase use of a Wye-connected secondary, only a single phase (L1) and neutral must be connected. This phase voltage must measure 230 V between line and neutral.

Warning: In this configuration, the charging station operates only from a single phase (L1). Do not connect the remaining phases L2 and L3.

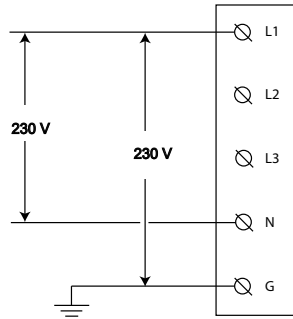

Option 3: 230 V 1-phase without neutral

In this configuration (without a neutral and 230 V from line to line), connect any two lines (L1, L2 or L3) to the L1 and neutral positions on the terminal block of the charging station.

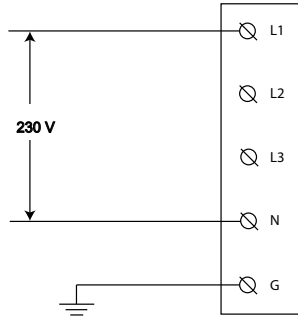

Note: In case you are not sure about the available connection type at the service panel, consult a qualified electrician.

2. Install wall dock

2.1

Select a solid and flat vertical surface for installing the wall dock.

Ensure that the surface is even and solid enough to resist a pull force of at least 100 kg.

2.2

Find the drilling template at the bottom of the box's sleeve. Cut the drilling template out from the sleeve.

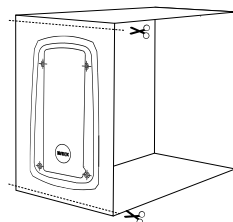

2.3

Place the drilling template onto the wall and use a level device (e.g. bubble level) to align the template. Mark the 4 mounting points on the wall and remove the template.

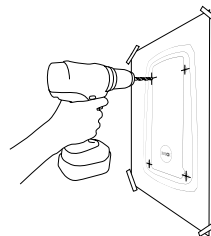

2.4

Drill holes with a drill round of 8 mm.

Use the provided 8x65 mm plugs.

2.5

Remove the transparent cover from the wall dock by undoing the 4 corner screws (3x Torx T20 using the supplied T20 bit and 1x slotted using a regular flat-head screwdriver).

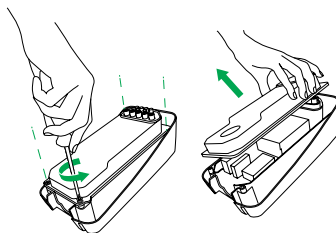

2.6

Mount the wall dock onto the wall.

Use the provided 5x70 mm screws. Use the supplied Torx T25 bit to fasten the screws.

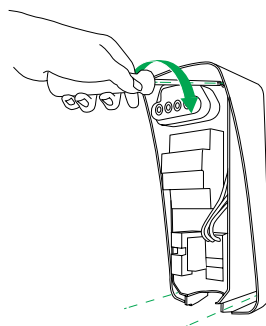

2. Install wall dock

2.7

Measure the power cable's diameter and cut out the correct diameter of the rubber seal in order to allow the power cable and optional data cables to get through.

Note: Strain relief and rubber seal are supplied in a separate bag in the box.

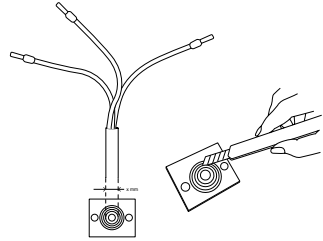

2.8

Feed the power line and optional data wiring through the rubber seal.

The total length of the power line fed through the rubber seal must be 180 mm.

Strip the power line over a length of 130 mm.

In case of stranded (flexible) wiring, use wire end sleeves with a ferrule length of 12-15 mm and apply a square crimp for optimal fit into the connection terminals.

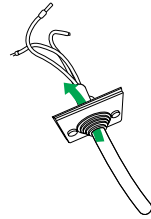

2.9

Assemble the strain relief.

Depending on the feed wire's thickness, use either the small or large diameter on the strain relief. Simply flip the symmetrical parts to obtain a different strain relief diameter.

The strain relief also accommodates for extra data cables on two sides (e.g. UTP/CAT5E/CAT6).

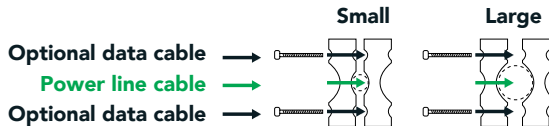

2. Install wall dock

2.10

Place one part of the strain relief in the bottom of the wall dock.

Place the feed wire over the bottom part of the strain relief and mount the rubber seal in the outer edge of the wall dock.

Note: Be aware that the rubber seal has three groove edges and one tongue edge. Make sure that you place the tongue edge facing upwards.

Place the top part of the strain relief over the feed wire and use the two 4 x 40 mm screws and the Torx T20 head to mount the strain relief on the feed wire. Do not overtighten.

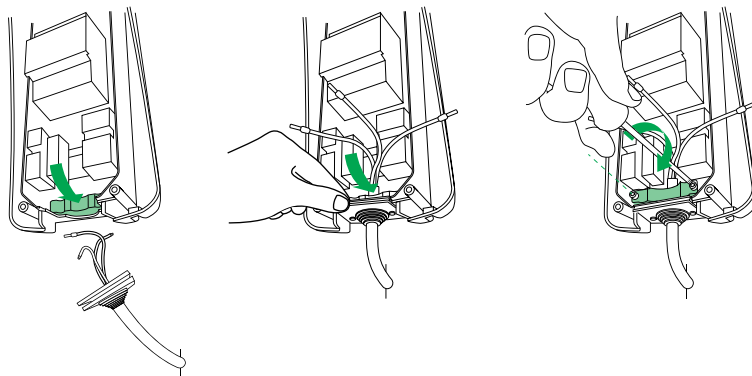

2.11

Connect the wires in their designated terminals. Mount the transparent cover.

Make sure no wiring is protruding from under the transparent cover.

Make sure that the rubber seal gasket around the connectors is in place before assembling the transparent cover.

Tighten the bolts with the T20 bit. Do not overtighten.

Fasten the special bolt in the bottom right corner with a regular flat-head screw driver. This special bolt can be used for sealing the installation with a tamper-evident seal.

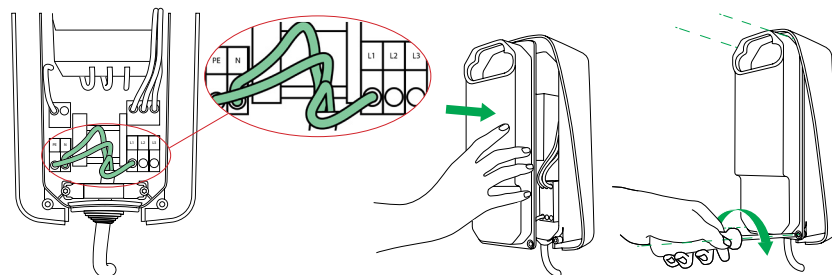

Note: Installation example of a 1-phase connection of Elvi.

3. Install charging cable

Tools you need to install the charging cable

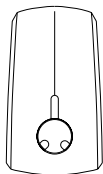
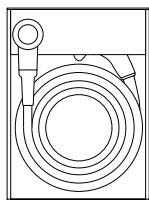

1x bit T30

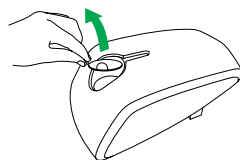

3.1

Unpack the charging cable box.
Remove the cardboard cover from the station's socket.

3.2

Take the charging cable out of the box.

Check that the rubber sealing ring on the charging plug is in place and not twisted. This is to ensure that the proper IP code (protection class) is met.

Place the charging station on its side and then plug the charging cable into the station.

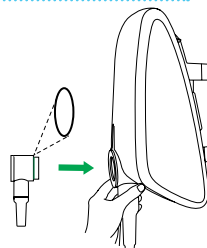

3.3

Make sure you press the charging cable until it is firmly secured.



3.4

Turn the station around and put the front face of the station on a soft surface. Place the bolt and firmly tighten the bolt with the T30 bit.

Reconfirm that the cable bolt is tightened properly.
Check again that the charging cable is firmly connected to the station.

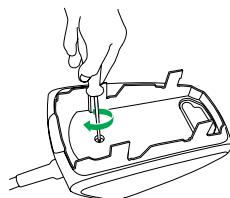

4. Activate Elvi

4.1

Download the mobile app for station management from your app store.
The app is available on both Android and iOS.

4.2

Log in to your account in the app.
If you don't have an account yet, create a new account in the app.
Register Elvi in the app by adding its station ID and security code.
Find the station ID on the back of your Elvi or in the supplied instructions folder inside the Elvi box.
Find the security code in the supplied instructions folder inside the Elvi box.
Find the charge card in the supplied instructions folder inside the Elvi box.

4.3

Follow the steps in the app to connect Elvi.

Note: The charging station operates with a Wi-Fi or cellular connection. Elvi will always search for Wi-Fi but it will choose the cellular connection when Wi-Fi is not found.

4.4

Activate your charge card in the mobile app for station management.
If you have a key fob, this needs to be registered separately from your charge card in the app.
Your charge card and key fob have separate ID numbers.

Your charge card/key fob tracks and registers all your charging sessions in your mobile app for station management and/or backend portal account as provided by the operator or service provider of this product.

Need more help?

If you need assistance with setting up Elvi, your mobile station management application and/or backend portal account, please contact your operator or service provider of this product for further support.

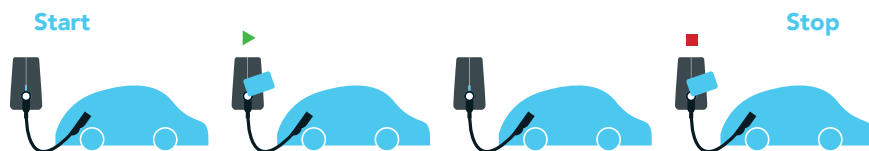

5. Install station

Tools you need to install the station

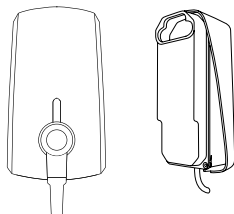

No specific tools needed for this step.

Before mounting, write down the Elvi station ID. This can be found on the backside of the station.

5.1

Align the station against the wall dock and press it in a straight line until you hear a clicking sound.

To ensure that the connection is fully secured, press firmly on all four corners and check that there is no air gap between the wall dock and the station.

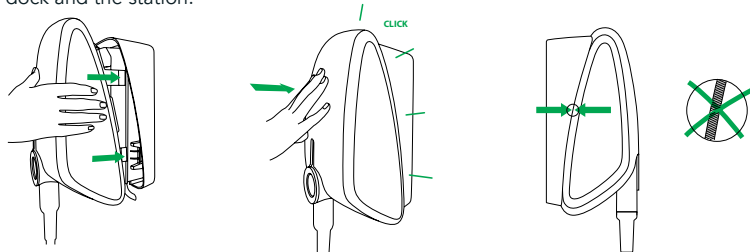

5.2

Switch on the power to the station on the service panel. Elvi will switch on automatically. This is indicated by a flashing red LED ring.

Note: If the LED ring does not show any color, it may be due to improper installation of the charging cable. In this case, check/repeat steps 3.3 and 3.4.

Note: Please be aware that soon after its registration and activation, Elvi might start a software update automatically. Do not switch Elvi off.

If the LED ring will not turn green after 20 minutes, verify that the station is online in the backend/portal account. If the station is not online, please contact your operator or service provider for this product



6. Install cable dock

sold separately

Tools you need to install the cable dock

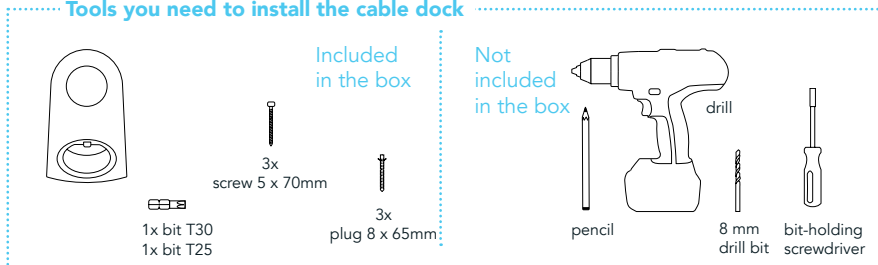

The Elvi cable dock is sold separately, part No. 290135.

6.1

Unpack your Elvi cable dock. Disassemble the charging cable holder by removing the Torx bolt with the T30 bit.

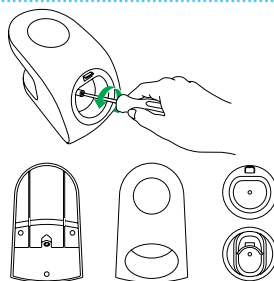

6.2

Place the cable dock's wall base on a solid and flat surface. Position the cable dock on the wall as illustrated (it should be to the side of your station and at a comfortable height within at least 1 meter from the ground).

Use the cable dock's wall base as a drilling template to mark the 3 holes to be drilled. Make sure it is level.

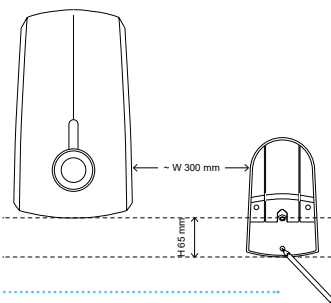

6.3

Drill holes with drill round 8 mm. Use the supplied plugs 8 x 65 mm.

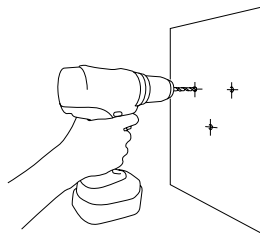

6. Install cable dock

6.4

Place the cable dock's wall base on the wall and fasten the three screws 5 x 70 mm length. Do not overtighten.

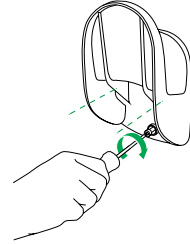

6.5

The Elvi cable dock is supplied with two plug holder options: one for Type 1 and one for Type 2 charging plugs. Choose the plug holder that corresponds to your charging cable and insert it into the cable dock. Fasten the bolt with the T30 bit. Do not overtighten.

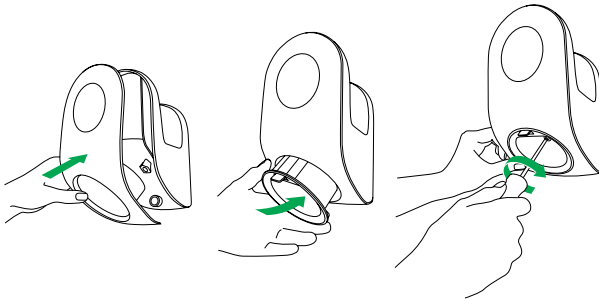

Success!
You're all set.

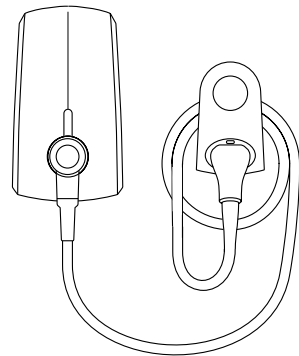

7. Change charging cable

Tools you need to change the cable

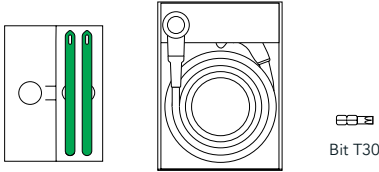

Warning: Risk of electric shock.

Before changing the charging cable, make sure that the power line you're using is switched off on your service panel. The LED ring of the charging plug must be off.

7.1

Take out the keys from the folder in the box. Insert the keys into the slots in the bottom of the wall dock. This releases the snap-fit connection of the charging station to the wall dock. Make sure to push them in until they only stick out approx. 50 mm and cannot be pushed in any further.

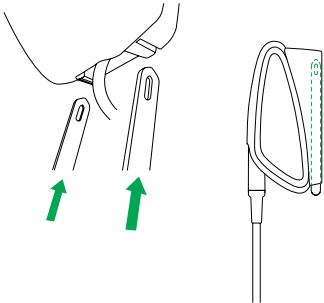

Now you can remove your charging station from the wall dock. Pull the charging station away from the wall dock in a straight line.

Important: Do not twist or skew the charging station, as that might damage the station's snap fits and/or connectors. Be aware that the charging station is still fixed on the connector (socket) of the wall dock and it requires some force to pull it off.

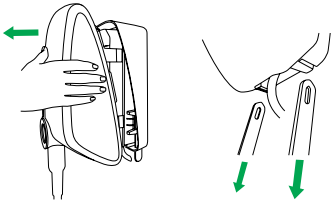

Take out the keys from Elvi wall dock.

7.2

Turn the charging station around and place the front face of the station on a soft and stable surface. Untighten the bolt in the back with the supplied Torx T30 bit and take the bolt out.

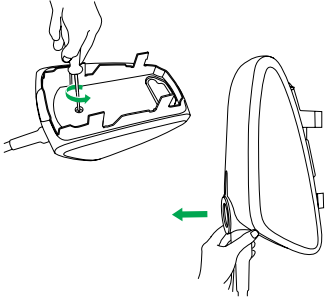

7.3

Place the station on its side and unplug the old cable out of the charging station. It is best to store the old cable in its original packaging.

7. Change charging cable

7.4

Take the charging cable out of the box.

Check that the rubber sealing ring on the charging plug is in place and not twisted. This is to ensure that the proper IP code (protection class) is met.

Place the charging station on its side and then plug the charging cable into the station.

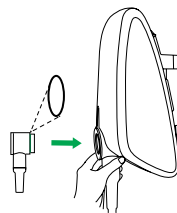

7.5

Turn the station around and place the front face of the station on a soft and stable surface.

Insert the bolt and tighten it firmly with the supplied Torx T30 bit.

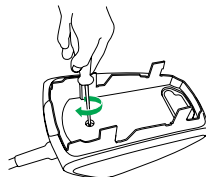

7.6

Reconfirm that the cable bolt is tightened properly.

Check again that the charging cable is connected firmly to the station.

Warning: double check that the charging cable plug is properly secured into the station with the bolt.



7.7

Align the station to the wall dock and the connectors and press until you hear a clicking sound. Keep a straight line while mounting the station. To ensure that the connection is fully secured, press firmly on all four corners and check that there is no air gap between the wall dock and the station.

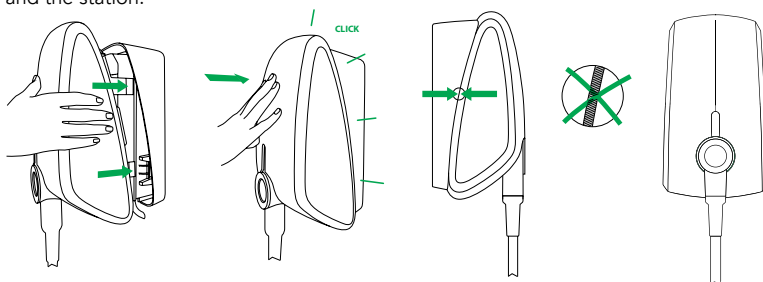

7.8

When upgrading your charging cable to a version that is suitable for higher power application, make sure that the applied RCD and MCB in the service panel are in line with local regulations, and are also adequate for the type of charging cable installed and the amount of power Elvi can supply (3.7, 7.4, 11 or 22 kW).

Check with your installer whether the selected output power from your Elvi can be supported by your local electrical installation. The setting of your maximum available amperage in the mobile app and/or web platform for station management may need to be adjusted to the new situation.







8. Charge with Elvi

Start charging

1. Plug the Elvi charging cable into your car.
 - If you're using a cable dock (optional) and a Type 1 cable, press the release button on the cable plug, then release the cable from the dock, and plug the cable into your car.
 - If you're using a cable dock (optional) and a Type 2 cable, press the release button on the cable dock, then release the cable from the dock, and plug the cable into your car.
2. To start or stop a charging session, you can use a registered charge card, key fob or your mobile app for station management.
3. Hold your charge card (RFID card) in front of the reader where it's marked with a .
4. Elvi reacts with a beep. This means that your card is being authorized.
5. The Elvi LED ring turns blue when it starts charging.

Stop charging

1. Hold your charge card (RFID card) in front of the reader where it's marked with a .
2. Elvi reacts with a beep. This means that your charge card/key fob is being authorized. The Elvi LED ring turns green when it stops charging.
3. Unplug the Elvi charging cable from your car and place it back into Elvi's cable holder. Alternatively, you can unplug your charging cable from your car directly and end your session.

What you see	What it means	What to do
 LED ring off or green	Elvi is ready for use.	Plug Elvi charging cable into the car.
 LED ring green, flashing	Your charge card is being verified.	Wait until LED ring turns blue.
 LED ring yellow	The car is fully charged.	Unplug Elvi charging cable from the car and place the cable back into Elvi cable holder.
 LED ring yellow, flashing	Charging session is in queue (applicable in the Smart Charging environment only).	When power becomes available, charging will start or resume, and the LED ring will turn blue.
 LED ring blue	Elvi is charging the car.	The car is charging.
 LED ring red	Elvi is experiencing an error.	Check the troubleshooting chapter in this manual for solutions. If this does not solve the issue, contact your installer or supplier of Elvi, or write us at support@evbox.com .
 LED ring red, flashing	Your charge card is not authorized to charge.	Contact your charge card service operator.

9. Troubleshooting

Problem	Possible cause	Solution
Charging station does not react	No power to charging station	<ul style="list-style-type: none"> • Check that the residual-current device and circuit breaker on the service panel are on (check by user). • Check that the supply cable entering the charging station is live. The LED ring should be on. • Turn the charging station off. Turn it on again after 20 seconds by flipping the circuit breaker or main switch to Elvi.
Residual-current device prevents charging. LED ring flashes red 10x.	<ul style="list-style-type: none"> • Grounding error in the charging station • Special ground resistance needed for the vehicle • Fault in the vehicle or defective charging cable 	Contact your service technician for inspection and solution. There are no user-serviceable parts.
LED ring lights up red constantly	Grounding fault	Check whether your electrical installation is properly grounded. Contact your service technician in case of doubt and for solving the local grounding situation.

See next page for more troubleshooting instructions.

9. Troubleshooting

Problem	Possible cause	Solution
LED ring lights up yellow constantly	<ul style="list-style-type: none"> • Vehicle is on a timer • Vehicle is fully charged • Grounding resistance is too high (with specific vehicles, this must be < 50 Ohm) 	<ul style="list-style-type: none"> • Check that the charging cable plug is inserted into the vehicle properly (check by user). • Change the setting of the timer in the vehicle (check by user). • Replace the charging cable (user-serviceable). • Check that the ground resistance is correct (grounding measurement by electrician).
Red LED starts flashing immediately after the card is held against the reader	<ul style="list-style-type: none"> • Charge card is not authorized for charging at this charging station • There is no communication with the mobile app for station management. 	<ul style="list-style-type: none"> • Check that the charge card is registered correctly (check by user). • Check the settings of your charging station in the mobile app and/or web platform for station management as provided by the operator or service provider for this product. For further details, contact your operator or service provider. • Check that there is proper Wi-Fi reception where Elvi is installed (check by user). • Reboot your Wi-Fi network first. Then reboot Elvi and check the Wi-Fi reception (check by user). • Check in the mobile app for station management that your Wi-Fi network is properly connected to Elvi. Reconnect again. (check by user) • If your Elvi is equipped with the optional UMTS module, check that Elvi is in contact with the local cellular network and that it has proper reception (check by charging point operator).

10. Warranty

6.1 EVBox warrants to Customer on delivery and for a period of three (3) years thereafter that the Products are free from material defects in material and workmanship and conform in all material aspects with the specifications as explicitly listed in the Documentation, except for charging cables, their connectors and software, for which the warranty is limited to three (3) months from delivery. Except as stated in this clause 6.1, EVBox provides no warranties of any kind in respect of the Products.

6.2 Subject to clause 6.3, EVBox shall, at its option, repair or replace defective Products, or refund the price of defective Products if:

- (a) Customer gives notice in writing during the warranty period within a period of fourteen (14) days after the Customer has discovered or should reasonably have discovered that some or all of the Products do not comply with the warranty as set out in clause 6.1;
- (b) Customer returns such Products to EVBox (at the location specified by EVBox) at Customer's cost and following the RMA (return merchandise authorization) instructions from EVBox, if the nature of the Product allows such return; and
- (c) EVBox is given a reasonable opportunity of examining such Products and provided by Customer with all information it may reasonably require to proceed to such examination.

With respect to repair, EVBox is entitled to apply problem avoiding restrictions and/or Workarounds.

6.3 EVBox shall not be liable for the Products' failure to comply with the warranty in clause 6.1 if:

- (a) Customer makes any further use of such Products after giving a notice in accordance with or failed to provide notification within fourteen (14) days as set out in clause 6.2;
- (b) The Error arises because Customer failed to follow EVBox's oral or written instructions as to the storage, installation, commissioning, use or maintenance of the Products or (if there are none) good trade practice (such as but not limited to use of the Products with parts, accessories or software not provided or approved by EVBox);
- (c) The Error arises as a result of EVBox following any customisation or Product specification supplied by Customer;
- (d) Repairs or other interventions on the Products are performed by persons not trained for this purpose, against EVBox's oral or written instructions, or with parts not supplied or approved by EVBox; or
- (e) The Error arises as a result of fair wear and tear, wilful damage or negligence by Customer and/or a third party, or abnormal working conditions (such as but not limited to damages resulting from vandalism, animals, high-pressure cleaners, or Error in connected vehicles).

6.4 In all cases, the following are excluded from the coverage of the warranty:

- (a) Travel costs and labour costs of repair, including time spent on preliminary work or on disassembly and reassembly, if the repair of the Products is to take place at the installation site due to the nature of the Products;
- (b) Cleaning, routine maintenance and preventative maintenance operations of the Products as defined in the Documentation, as well as the supply of products necessary for these operations;
- (c) Restarting operations after the Product has been secured, for example by circuit breakers, ground fault circuit interrupters (GFCIs), fuses or emergency stops; and
- (d) In general, all operations on site, especially if no parts need to be replaced.

6.5 The Agreement shall apply to any repaired or replacement Products supplied by EVBox. This warranty statement is subject to change.

Please refer to evbox.com/general-terms-conditions for the latest version.

11. Declaration of conformity

EVBox B.V.,

NL registration KvK 32165082_000018683428
Fred. Roeskestraat 115, 1076 EE Amsterdam, The Netherlands

declares under its' sole responsibility that the following products:

- Article series E1160-XX50XX: EVBox Charging station, 1-phase 16 A with charging cable
- Article series E1320-XX50XX: EVBox Charging station, 1-phase 32 A with charging cable
- Article series E3160-XX50XX: EVBox Charging station, 3-phase 16 A with charging cable
- Article series E3320-XX50XX: EVBox Charging station, 3-phase 32 A with charging cable

provided that they are installed, maintained and used in the applications for which they were designed, in accordance with professional practices, relevant installation standards and manufacturer's instructions for use and installation, are CE certified and comply with the essential requirements of EMC Directive 2014/30/EU, Low Voltage Directive 2014/35/EU and RED Directive 2014/53/EU in accordance with the following standards:

EN/IEC 61851-1 (2017)
EN/IEC 61851-21-2 (2018)
EN/IEC 61000-3-2 (2014)
EN/IEC 61000-3-3 (2013)
EN 301 489-1 V2.2.0
EN 301 489-3 V2.1.1
EN 301 489-17 V3.2.0
EN 301 489-52 V1.1.0
EN 301 908-1 V11.1.1
EN 301 511 V12.5.1
EN 300 330 V2.1.1
EN 300 328 V2.1.1
EN 301 893 V2.1.1
EN 300 220-1 V3.1.1
EN 300 220-2 V3.1.1

Amsterdam, June 25th 2019



Arjan van Rooijen

Chief Technical Officer

The present document is drawn up by way of information only and does not constitute an offer binding upon EVBox. EVBox has compiled the contents of this document to the best of its knowledge. No express or implied warranty is given for the completeness, accuracy, reliability or fitness for particular purpose of its content and the products and services presented therein. Specifications and performance data contain average values within existing specification tolerances and are subject to change without prior notice. Prior to ordering, always contact EVBox for the latest information and specification. EVBox explicitly rejects any liability for any direct or indirect damage, in the broadest sense, arising from or related to the use and/or interpretation of this document. EVBIM_072019 © EVBox Manufacturing B.V.

EVBox strives to manufacture products of the highest quality. EVBox products are fully CE certified and compliant with the essential requirements of EMC Directive 2014/30/EU and Low Voltage Directive 2014/35/EU. More details can be found at evbox.com or in this installation manual. EVBox products are sold with a limited warranty described at evbox.com/general-terms-conditions.

© 2019 EVBox Manufacturing B.V. All rights reserved. Elvi®, EVBox® and the EVBox logo are trademarks or registered trademarks.

EVBox Manufacturing B.V.
Fred. Roeskestraat 115,
1076 EE Amsterdam
evbox.com/support



RoHS
Compliant



